

**MEDIASTILE**  
ESCLUSIVISTA ITALIA

NUOVA COLLEZIONE LED & DIGITALE



VITRINE MEDIA





## SOMMARIO

VM ONE	p. 4 - 5
VM TWO & VM TWO COLORS	p. 6 - 7
VM PANORAMIC BANNER	p. 8 - 9
VM WALL	p. 10 - 11
VM MOBILE STAND EASY CLIP	p. 12 - 13
CARTA BACKLIGHT	p. 14 - 15
VM GRANDI FORMATI LCD	p. 20 - 21
VM LIGHT & PLAY	p. 22 - 23
Estensione di garanzia LONGLIFE	p. 24 - 25

# REMARQUABLE & UNIQUE

---

Per voi, per noi, essere conosciuti e riconosciuti è l'obiettivo di una vita.

La nostra volontà, da sempre, è quella di contribuire con semplicità al vostro successo. Oggi, vogliamo andare oltre ed è con grande entusiasmo che Vi presentiamo la Nostra collezione .

Questa, raccoglie un concentrato d'innovazione e di nuovi servizi di personalizzazione per permetterVi di fare la differenza e di affermare la Vostra unicità :

- **Cambiate look** grazie al VM TWO COLORS
- **Comunicate più efficacemente** grazie a VM PANORAMIC BANNER
- **Comunicate diversamente** con VM WALL
- **Mostrate la vostra cura per i dettagli** utilizzando le nostre gamme di carta backlight
- **Rendete dinamica la Vostra comunicazione** con i nostri schermi VM GRANDI FORMATI LCD
- **Unite le tecnologie** con il nostro concetto VM LIGHT & PLAY.

**Voi siete REMARQUABLE & UNIQUE, mostratelo !**

Thibault Guillaume  
CEO VitrineMedia

Schermo dal design ricercato ed elegante con agganci a vista in metallo cromato, contorni cromati, affilati e luminosi. Alternare i formati degli schermi non é mai stato così semplice.

## MODELLI DISPONIBILI

Verticale e orizzontale

## FISSAGGI INNOVATIVI

Sistema di aggancio innovativo per un'installazione semplice e rapida.

## INGOMBRO RIDOTTO

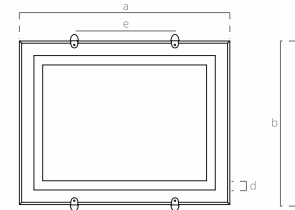

10 mm di spessore.

## DIMENSIONI (mm)



	A	B	C	D	E
A4	334	247	10	21	170
A3	457	334	10	21	170
A2	631	457	10	21	170
A1	878	631	10	21	170

## DATI TECNICI

-  Colori Bianco/Cromato
-  Luminosità  
6 400 LUX (A4)
-  Bassa tensione  
24 Volts
-  80 000 ore  
di utilizzo

TOP GAMMA

VI ONE

Esprime la sua bellezza attraverso  
le sue eleganti finiture cromate

*Reinventa l'eleganza*

*in tutta semplicità*



Con il suo design puro, minimalista, una finitura ad angoli arrotondati ed i fissaggi nascosti, questo schermo offre multiple configurazioni di installazione grazie al suo formato polivalente verticale/orizzontale ed ai suoi colori bianco/argento e nero.

**ORIENTAZIONE IBRIDA**  
Verticale o orizzontale.

**FISSAGGI INNOVATIVI**  
Sistema di aggancio innovativo per un'installazione semplice e rapida.



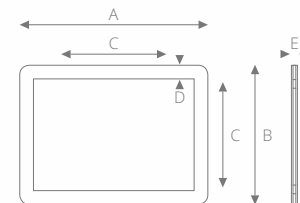

**INGOMBRO RIDOTTO**  
10 mm di spessore.

## DIMENSIONI (mm)



	A	B	C	D	E
A4	334	247	170	21	10
A3	457	334	170	21	10
A2	631	457	170	21	10
A1	878	631	170	21	12
A0	1251	903	560	35	13,5

## DATI TECNICI

-  Colori Bianco/Argento o nero
-  Luminosità  
6 400 LUX (A4)
-  Bassa tensione  
24 Volts
-  80 000 ore di utilizzo

NOVITA'

Personalizzate la Vostra vetrina customizzando le cornici dei Vostri schermi VM TWO con :

VI TWO COLORS



*Essere unici, significa cambiare look*

*come lo desiderate*

# VM PANORAMIC BANNER

## RIVOLUZIONATE

la comunicazione con VM Panoramic Banner. Questi schermi dal formato innovativo ed ibrido vi permettono di aumentare la vostra visibilità comunicando con eleganza rispettando i canoni estetici dell'esposizione in vetrina.



ORIENTAZIONE IBRIDA  
Orizzontale o verticale

## DIMENSIONI (mm)

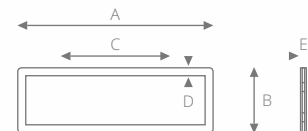

**S** (dim. visual : 1020X350)

A	B	C	D	E
1082	412	600	35	12

**L** (dim. visual : 1390X350)

A	B	C	D	E
1454	412	600	35	12

## DATI TECNICI

-  Colori Bianco/Argento o nero
-  Luminosità 64000 LUX
-  Bassa tensione 24 Volts
-  80 000 ore di utilizzo



**Selling your home?**  
LJ Hooker hold over a million open homes a year.



**SALES**

**Hi** Welcome to the world's best real estate company.



**Welcome**

**Invest in your future.**



**RENTALS**



**Sold**



VM WALL E' LA SOLUZIONE DI ESPOSIZIONE A MURO di VitrineMedia. E' caratterizzata dalla sua semplicità d'installazione grazie all'assemblaggio di alcuni elementi: fissaggi murali, barre ed espositori VM TWO CLIP.

## MODULARITA'

Possibilità di combinare differenti formati (A4/ A3/ A2/A1) ed orientazioni ( orizzontali o verticali ) grazie al suo sistema di « clips ».

## DIMENSIONI (mm)

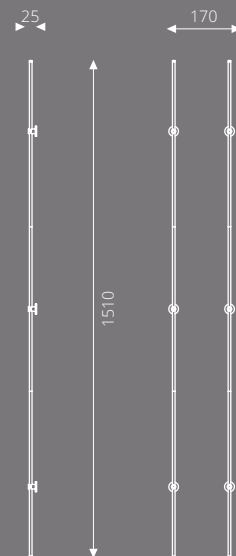

VI TWO CLIP



# VM MOBILE STAND EASY CLIP



VM MOBILE STAND EASY CLIP permette delle configurazioni multiple grazie al suo sistema di fissaggi « clip ». Utilizzabile con la gamma VM TWO CLIP.

## INSTALLAZIONE FACILE

I montaggi e gli smontaggi del VM MOBILE STAND EASY CLIP sono semplici e rapidi.

## TRASPORTABILE E POCO INGOMBRANTE

Concepito per occupare meno spazio possibile in vetrina e nel Vostro locale.



VM TWO CLIP

## DIMENSIONI (mm)

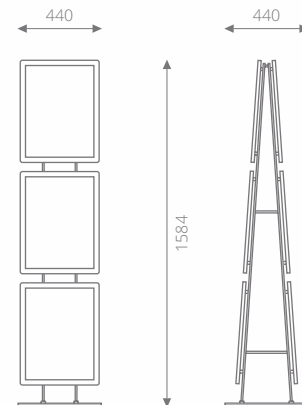



*Essere unici, significa comunicare dovunque vogliate*

# BACKLIGHT & CARTA PREMIUM

Il Backlight VitrineMedia è stato concepito nello specifico per massimizzare l'impatto dei vostri visual negli espositori LED VitrineMedia. Vi permette di stampare i Vostri annunci semplicemente, garantendovi un risultato straordinario.



CARTA  
SPECIALE

CARTA  
NORMALE



**Backlight 100G.**  
Per stampanti o  
fotocopiatrici laser.

**Backlight 125G.**  
Per stampanti a getto  
d'inchiostro.

**NOVITA'**



LA QUALITA' VITRINEMEDIA  
ACCESSIBILE A TUTTI

**Carta PREMIUM**

Per stampanti o  
fotocopiatrici Laser.



**Backlight 180G.**

Per stampanti Laser.

(compatibile con alcune stampanti a  
getto d'inchiostro)

Carta ordinaria  
VS  
**Carta PREMIUM & Backlight**

LUMINOSITÀ

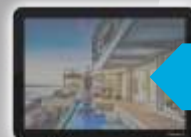

Carta ordinaria 80g.



**Carta PREMIUM** (93g.)



**Backlight 125g.**



**Backlight 180g.**



**Backlight 100g.**



*Essere unici*

*significa mostrare la propria attenzione ai dettagli*







TUTTE LE NOSTRE REALIZZAZIONI SONO VISIBILI **ON LINE**

[WWW.VITRINEMEDIA.IT](http://WWW.VITRINEMEDIA.IT)  
[WWW.MEDIASTILE.IT](http://WWW.MEDIASTILE.IT)

VITRINEMEDIA

DIGITAL SERVICES



# VM GRANDI FORMATI LCD

NOVITA'

DIFFONDETE IL VOSTRO CONTENUTO  
DINAMICO IN TUTTA SEMPLICITA'





Grazie alla nostra applicazione Dynalive, potete facilmente creare e modificare il contenuto da pubblicare sui Vostri schermi, in funzione delle Vostre necessità commerciali.

## DIMENSIONI (mm)

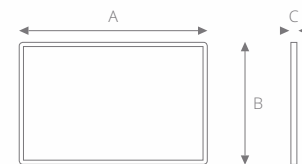

**32'**

A	B	C
732	447	96

**49'**

A	B	C
1092,7	626,4	83,5

**55'**

A	B	C
1238,4	712,4	89

## DATI TECNICI



Risoluzione schermo  
1920x1080p



Luminosità  
2500cd/m<sup>2</sup>



Orientazione ibrida  
Orizzontale/Verticale





VM LIGHT&PLAY si integra alla nuova gamma dinamica di VitrineMedia.

Sobrio ed elegante, si adatta perfettamente a qualsiasi sistema di esposizione VitrineMedia già esistente (VM CABLE, VM WALL, VM BOX, VM MOBILE STAND EASY CLIP). Inserite i vostri video su chiave USB o su una scheda SD, connettete VM LIGHT&PLAY ed i video si lanceranno automaticamente.

ORIENTAZIONE IBRIDA  
Orizzontale o verticale



UNO SCHERMO,,  
INFINITE POSSIBILITA'



WI CABLE



WI WALL



WI STAND

DIMENSIONI (mm)

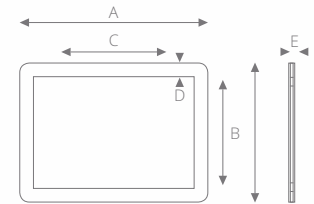

21,5'

A	B	C	D	E
527	323	170	29	16

PRESTO DISPONIBILE  
IN 18,5' E 24'

DATI TECNICI

-  Risoluzione schermo  
1920x1080p
-  Formati compatibili  
Vidéos/Images
-  Orientazione ibrida  
Orizzontale Verticale



### *Estensione di garanzia dei prodotti VM a 3 - 5 anni*

*LONGLIFE di MediaStile è un servizio che prevede l'estensione della garanzia standard del produttore VITRINEMEDIA in modo che i vostri acquisti siano garantiti nel tempo.*

*LONGLIFE è sinonimo di tranquillità e qualità. Per i clienti che desiderino una ulteriore garanzia sui prodotti VM sono a disposizione le due formule che estenderanno la garanzia standard fino a 5 anni.*

*Le estensioni di garanzia LONGLIFE a disposizione dei clienti sono di due tipi: LONGLIFE3 (durata estesa fino a 3 anni) e LONGLIFE5 (durata estesa fino a 5 anni).*

*I clienti che si avvarranno, per le l'installazione delle loro vetrine, del personale tecnico di MEDIASTILE, riceveranno il prodotto LONGLIFE3 in omaggio.*



*Per maggiori informazioni sulle caratteristiche dei prodotti LONGLIFE, vi invitiamo a rivolgervi al vostro commerciale di riferimento.*

# LONGLIFE





NOVITA'

## LONGLIFE

Le nostre estensioni di garanzia assicurano il Vostro investimento nel tempo

1

**10 ANNI**  
di attività

2

**5 FILIALI**  
(Spagna, Portogallo, Australia,  
Canada, Giappone)

3

Oltre **1.000.000**  
**SCHERMI VENDUTI**  
in tutto il mondo

4

**LO SPECIALISTA NELLA  
VISIBILITA' DEL PUNTO  
VENDITA**

Con un tasso di penetrazione del 50%  
in tutti i Paesi Europei in cui il Marchio  
è presente

5

**28 PAESI**  
Membri della rete

**MEDIASTILE**  
ESCLUSIVISTA ITALIA  
concessionario Italiano

6

**30 000 CLIENTI**  
nel mondo

7

**220 COLLABORATORI**  
In tutto il mondo

8

Sede sociale a  
**BOULOGNE-BILLANCOURT,**  
Francia

9

Un polo  
**R&D, PRODUZIONE E QUALITA'**  
VitrineMedia Manufacturing

# LA NOSTRA PRESENZA

SEDE, R&D & FILIALI





BE  
REMARKABLE

VitrineMedia France  
50 Route de la Reine  
92 100 Boulogne-Billancourt  
FRANCE  
+33 (0)1 49 21 00 61

---

### VitrineMedia Italia / Mediastile Srl

*Amministrazione e servizi:* Regione Sgorre, 12  
17031 - Albenga ( SV ) ITALIA

*Sede legale:* Via Papa Giovanni XXIII, 162/2  
17031 - Albenga ( SV ) ITALIA

**Tel. 0182 1986000**

[www.vitrinemediastile.it](http://www.vitrinemediastile.it)  
[www.mediastile.it](http://www.mediastile.it)  
[info@mediastile.it](mailto:info@mediastile.it)



ESCLUSIVISTA ITALIA



**Fabio Bernardini**  
Sales Manager  
[f.bernardini@mediastile.it](mailto:f.bernardini@mediastile.it)  
+39 348 8262417

SEGUITECI



v. 2.30